

M8 分线盒 (线缆式 / 接插式)

线缆式

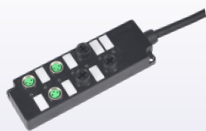

S010-M8-4/4P/4C



S010-M8-6/6P/6C

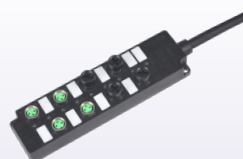

S010-M8-8/8P/8C

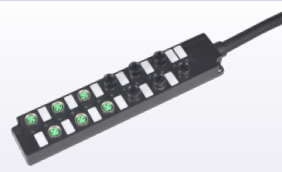

S010-M8-12/12P/12C

接插式



S011-M8-4/4P/4C



S011-M8-6/6P/6C

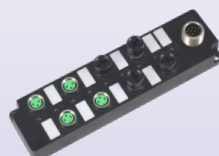

S011-M8-8/8P/8C

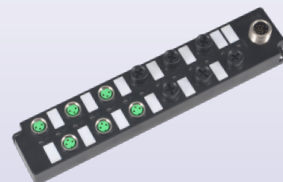

S011-M8-12/12P/12C

产品特点

- ◎ 防水设计，等级可达 IP67；
- ◎ 带有 LED 显示，动作状态一目了然；
- ◎ PVC 线材，标准长度有 3 米、5 米、7 米、10 米。
- ◎ 业界最小尺寸，便于现场狭小空间安装；
- ◎ 提供 4、6、8、12 位产品；
- ◎ 线缆式、接插式两种设计，实现快速连接，非常简便。



选型指导

型号 名称	4 位分线盒	6 位分线盒	8 位分线盒	12 位分线盒	适配线缆
线缆式	S010-M8-4/4P/4C	S010-M8-6/6P/6C	S010-M8-8/8P/8C	S010-M8-12/12P/12C	/
接插式	S011-M8-4/4P/4C	S011-M8-6/6P/6C	S011-M8-8/8P/8C	S011-M8-12/12P/12C	详情请参阅本手册 线缆线系列，页码 指引 P204

3 芯连接器

型号	M8-3AM (手册第 328 页)
针脚数	3
出线直径	3.5 ~ 5mm
额定电流 / 电压	4A/60V
温度范围	-25 ~ 85°C
防护等级	IP67

规格参数

额定电流	单通道 2A，总共 6A
额定电压	DC24V

脚位 - 导线颜色对应表

S010-M8-4/4P/4C S011-M8-4/4P/4C

孔位	P	N	01	02	03	04
颜色	棕	蓝	黑	红	橙	黄

S010-M8-6/6P/6C S011-M8-6/6P/6C

孔位	P	N	01	02	03	04	05	06
颜色	棕	蓝	黑	红	橙	黄	绿	紫

S010-M8-8/8P/8C S011-M8-8/8P/8C

孔位	P	N	01	02	03	04	05	06	07	08
颜色	棕	蓝	黑	红	橙	黄	绿	紫	灰	白

S010-M8-12/12P/12C S011-M8-12/12P/12C

孔位	P	N	01	02	03	04	05	06	07	08	09	10	11	12
颜色	棕	蓝	黑	红	橙	黄	绿	紫	灰	白	棕	黑	红	白

订货范例

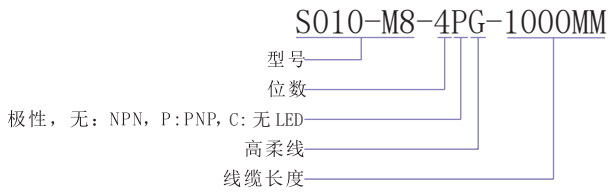

●备注: 标准长度有 3 米、5 米、7 米、10 米。

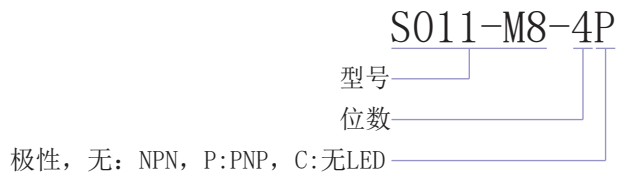

外形图

S010-M8-4/4P/4C

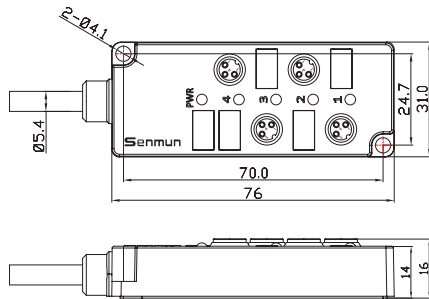

S010-M8-6/6P/6C

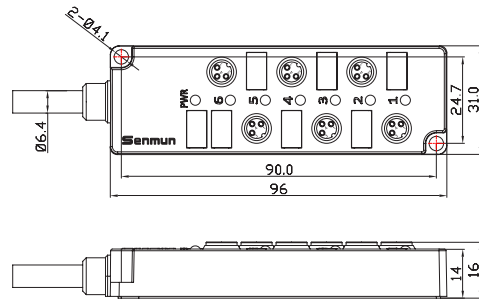

S010-M8-8/8P/8C

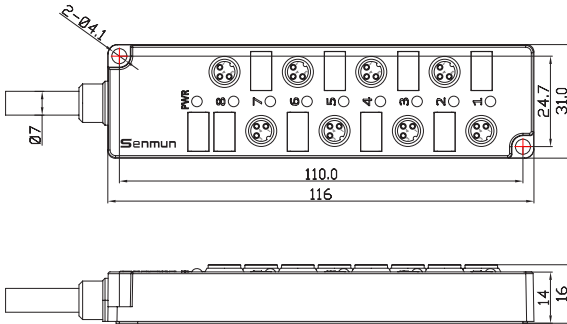

S010-M8-12/12P/12C

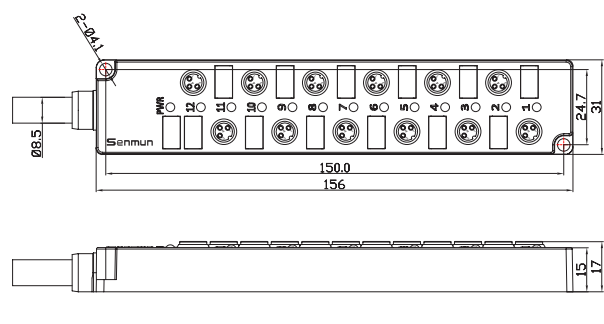

S011-M8-4/4P/4C

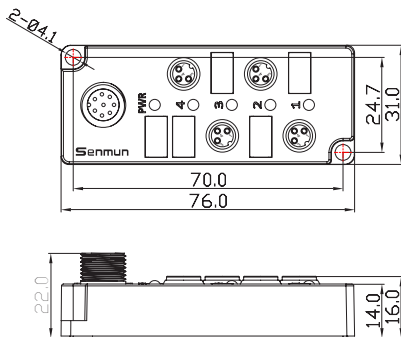

S011-M8-6/6P/6C

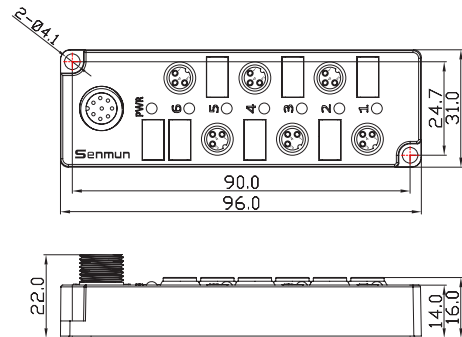

分类

- 总线模块
- 端子台
- 继电器模组
- 电缆线
- 传感器

选型指南

外形图

S011-M8-8/8P/8C

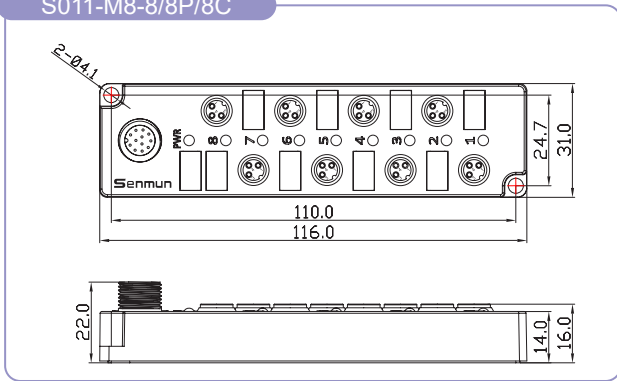

S011-M8-12/12P/12C

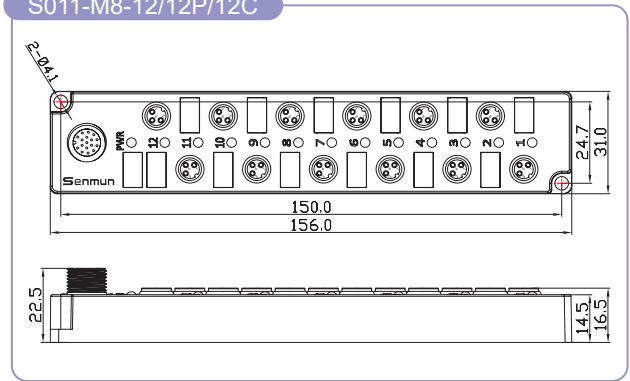

分类

总线模块

端子台

继电器模组

电缆线

传感器

配线图

S010-M8-4 S011-M8-4

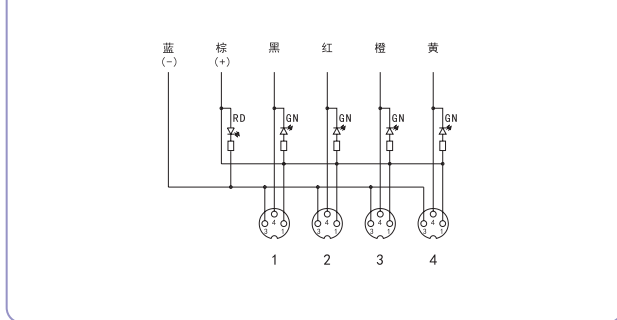

S010-M8-4P S011-M8-4P

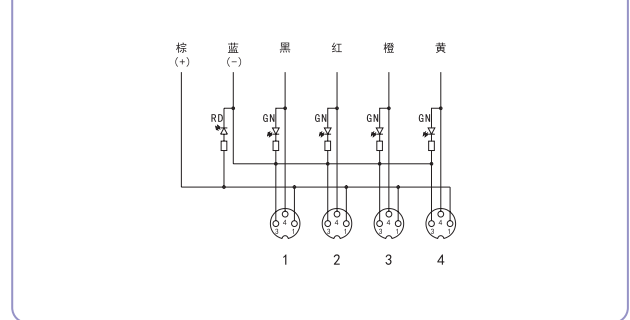

选型指南

S010-M8-4C S011-M8-4C

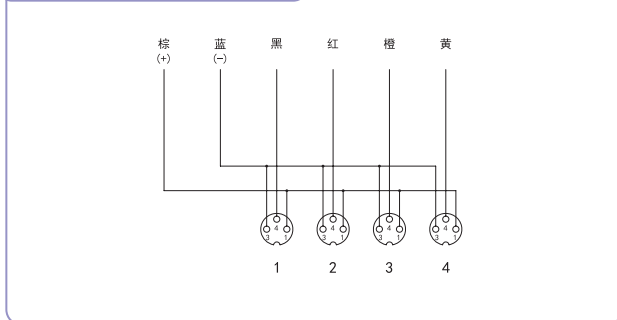

S010-M8-6 S011-M8-6

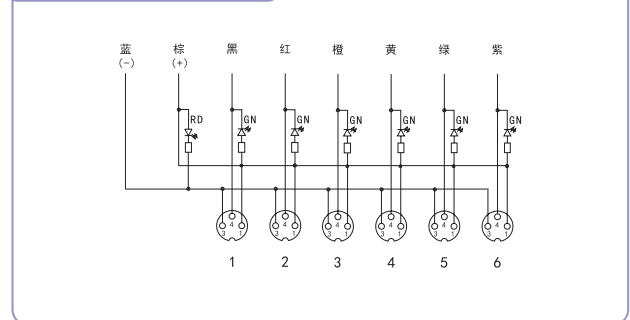

S010-M8-6P S011-M8-6P

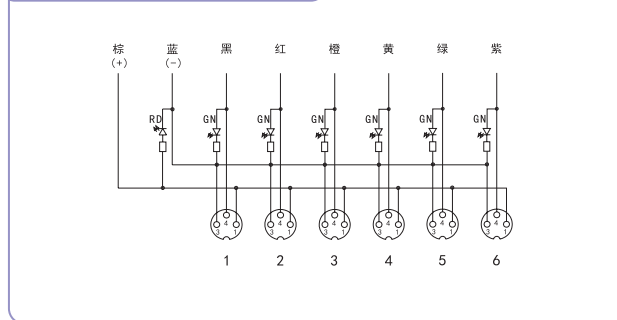

S010-M8-6C S011-M8-6C

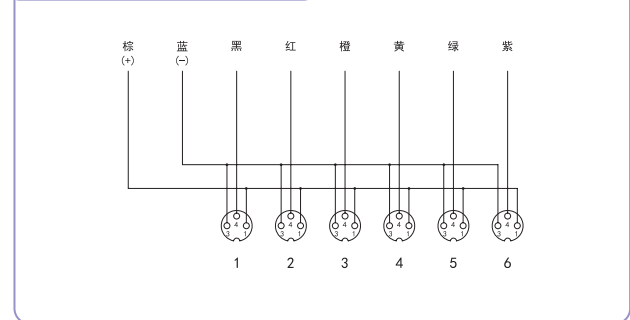

配线图

S010-M8-8 S011-M8-8

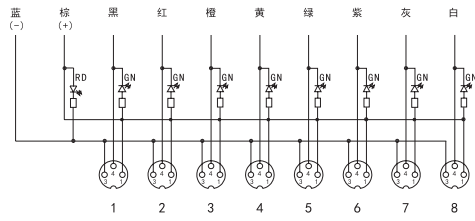

S010-M8-8P S011-M8-8P

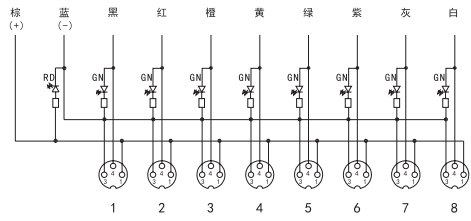

S010-M8-8C S011-M8-8C

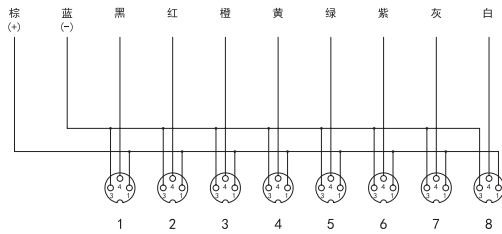

S010-M8-12 S011-M8-12

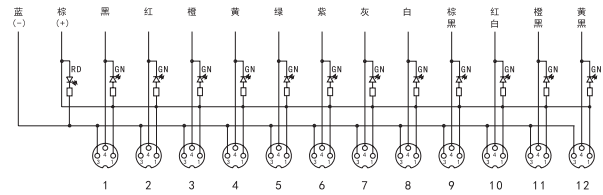

S010-M8-12P S011-M8-12P

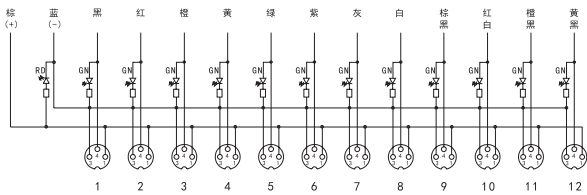

S010-M8-12C S011-M8-12C

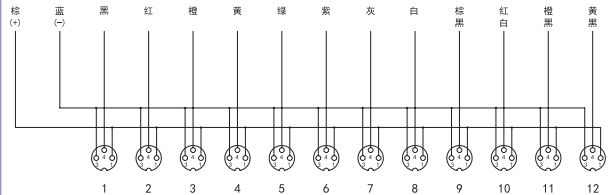

分类

总线模块

端子台

继电器模组

电缆线

传感器

选型指南